

GENERAL RULES

GENERAL RULES DISCLAIMER:

The rules, regulations, procedures and information set forth herein are designed to provide for the orderly conduct of motor racing events and to establish minimum acceptable requirements for such events. These rules shall govern the condition of all COLORADO NATIONAL SPEEDWAY (CNS) events, and by participating in these events, All NASCAR members and non-members are required to comply with these rules. No expressed or implied warranty of safety shall result from the publication of, or the compliance with these rules, regulations or procedures. They are intended as a guide for the conduct of the sport and are in no way a guarantee against injury and/or death to participants, spectators or any others.

Competitors are solely and directly responsible for the safety of their race cars/trucks and racing equipment, and are obligated to perform their duties (whether as a car/truck owner, driver, or mechanic) in a manner designed to minimize to the best degree possible, the risk of injury to themselves and others. Any car/truck deemed to be unsafe by CNS officials, to compete or continue, may be sent to the pit area at any time. The CNS Track Promoter, Track Officials, Track personnel, and/or NASCAR are not responsible for the adequacy of a competitor's race vehicle, racing equipment, or racing activity to accomplish this.

No pretense is made for having designed a foolproof set of rules and regulations. The spirit and intent of the rules is the standard by which Events will be governed. The Track Steward is authorized to decide if an equipment change or modification is an attempt to circumvent these rules. The Track Steward can and will disqualify a race car in violation of the spirit and intent of these rules. If this rulebook does not specifically state that you can alter, change, or otherwise modify something on your car, you should consider it a violation of these rules. No part is deemed to have been approved by passing through prior technical inspections.

ADMISSION PRIVILEGE:

Colorado National Speedway is considered Private property. Unauthorized presence is considered trespassing, and violators are subject to the penalties prescribed by law. Through your membership license, registration, and/or admission tickets, you have been given license to be on Colorado National Speedway property in conjunction with racing activities. The management of Colorado National Speedway and/or Officials reserve the right to revoke and/or cancel this license at any time that it is deemed that a participant's or spectator's presence or conduct is not in the best interests of the sport of auto racing, fellow competitors, spectators, management, officials, and/or employees of Colorado National Speedway.

GENERAL RULES:

We welcome all drivers, owners, and crew members to Colorado National Speedway. All drivers must be of legal driving age as defined by each Division's respective Rules, and those participating in a NASCAR sanctioned division must hold a current NASCAR driver's license.

The minimum age for competitors is as follows by Division:

- Super Late Model, Pro Truck, Late Model, Grand American Modified, Figure 8, Super Stock, Pure Stock, and Demo Cross: 14 years old.
- Bandolero: 8 years old.
- Any visiting class (Super Modified, Big Rigs, etc.): 14 years of age

A CNS minor release form will be required for competitors 8 to 17 years of age. The standard NASCAR Minor Release must be signed each time a minor enters the Pit Area.

NASCAR license applications may be obtained from CNS offices or from NASCAR directly. All working crew members in any one of the sanctioned NASCAR divisions must also purchase a NASCAR membership. All vehicles must be registered with CNS and be assigned a number at the cost of \$75.00 each. CNS reserves the right to deny eligibility to any applicant. The current year competitor's numbers and pit stalls will be held until every Division has competed at least one time. Any Number or Pit Stall not registered as of this date will become available on a first come, first served basis. Current year Registered numbers not used in competition before July 1st will be released with no refunds. Both sides of Registration Form must be legibly completed in full and signed by the competitor prior to participation in any CNS racing events, including practice.

All drivers, in all divisions, must have a fully paid and completed current year Registration Form, with properly assigned car number, prior to competing in any event (including qualifying races). Two Drivers MAY NOT share the same Registration / Car number (i.e. two Drivers + one car = *two* Registrations). There will be no duplicate numbers and /or letters used. It is every DRIVER'S RESPONSIBILITY to register his/her vehicle and draw a qualifying pill for every event at the lower level of the Pit Tower, ***no later than 3:00pm*** unless otherwise posted.

INJURY CLAIMS: NASCAR and/or CNS' insurance policy acts as secondary claim agent to primary personal insurance **ONLY** if processed on the date of the incident. Therefore, any incident which occurs on the Track or in the Pit Area which results in an injury **MUST** be reported to the Pit Steward or CNS Security immediately following the incident. Be sure to provide the Speedway Representative with your Pit Pass (wristband) while filing a report. Any incident submitted after the date of occurrence and / or without a Pit Pass will not be processed, resulting in a loss of any potential coverage. Refusal to cooperate with Official / Security filling out an Incident Report will result in a loss of potential coverage.

DRIVER RESPONSIBILITIES:

CNS Management reserves the right to accept or deny eligibility to anyone. CNS will not allow any type of 'passengers' during any race, practice, or otherwise in these divisions. Shirt, long pants, and closed-toe shoes are required by all active crewmembers. (No Sleeveless shirts are allowed). Each driver must sign in and/or draw a qualifying pill at the lower level of the Pit Tower prior to 3:00pm or as announced. At all events, the driver assumes responsibility for the actions of his/her pit crew and owner (including any unpaid fines) of which will be deducted from the driver's purse. If you have any complaints, they will be reviewed in an orderly manner.

DRIVER AND CREW CHIEF MEETINGS:

Attendance at all driver and crew chief meetings is mandatory. Unexcused absence will result in loss of starting position. CNS will notify drivers and Crew Chiefs in advance, of time and place where the drivers' meetings will occur. Roll call may be taken. Drivers and Crew Chiefs are responsible for conveying any new or important information discussed during these meetings to their crews and car owner. These meetings are for Driver's and Crew Chiefs only.

CONDUCT:

DRIVER'S ACKNOWLEDGMENT:

I agree that I shall be the sole spokesperson for myself, the car owner, and the crew in all matters pertaining to compliance with the rules and regulations, and I agree and understand that I am responsible for the conduct of my crew. Drivers alone will be held responsible for the behavior of themselves, crewmembers, owners and any other personnel connected with that team. Penalties may be enforced against an entire team for conduct infractions committed by any one member.

Unsportsmanlike conduct such as hand gestures, foul language, throwing of objects, on-track retaliations or visual display of bad temper by drivers or their crew and owners will result in appropriate penalties. A "start

and park” is hereby deemed to be unsportsmanlike, and will result in zero points and zero purse awarded.

Fighting is strictly prohibited. There will be absolutely no excuses or exceptions to this rule. This rule is not appealable and CNS Officials decisions are final.

An owner, driver or crewmember, initiating or participating in a fight may cause the team(s) loss of points; purse/point money accumulated by team(s) and may result in Legal action, disqualification, ejection, License revocation or suspension of team(s) or individual(s) at the discretion of CNS officials.

- a. Verbal abuse or physical threats (including on social media) made to CNS officials, track employees, fans, fellow competitors, etc. by any owner, driver or crewmember will not be tolerated and will result in appropriate penalties up to and including suspension, loss of points, and monies.
- b. Deliberate reckless behavior by owners, drivers, crewmembers or other team members, on or off track, endangering the safety of officials, track crews or fans, will result in penalties at the discretion of CNS officials

ALCOHOL:

No alcoholic beverages or controlled substances may be brought on to Colorado National Speedway premises at any time. You and/or your vehicle may be subject to search while at Colorado National Speedway. Consumption of alcohol / controlled substances before or during a race or while you are in the pit area is strictly prohibited. After the last feature event is started, **Only** Alcohol sold at CNS is allowed to be consumed in the pits. **Absolutely no alcohol consumption is allowed in the parking areas.** Driver will be subject to a fine and/or suspension for himself or any member of his/her crew, etc. for breaking the above rules. CNS reserves the right to require or randomly test for alcohol or any controlled substance at any time. Consumption or use of drugs and/or alcohol prior to and/or during CNS events is prohibited. By registering, competing and/or entering the CNS facility you agree to such test without exception.

CNS Social Media Policy

Colorado National Speedway defines social media as all means of electronic communication or posting of information/content of any sort on the internet. This includes but is not limited to your own or someone else's web blogs, personal website, social networking or affinity website, whether or not directly associated or affiliated with CNS. This includes but is not limited to Facebook, Snapchat, “X” formerly known as Twitter, Instagram, Threads, TikTok, YouTube, Reddit, LinkedIn, and Podcasts. Individuals are solely responsible for what is posted online: whether by themselves and/or allowing others the ability to post online content for them.

This social media policy applies to all CNS competitors, crew and their guests. A competitor is a driver, entrant, family member, crew member (non-driver), or any other individual or entity who is a member and/or participates in any CNS event. All drivers are responsible for the actions of their crew and guests.

Any social media interaction or contribution that adversely affects CNS, other members, or others directly/indirectly related to the track will result in disciplinary action against individuals, up to and including:

- 1st Offence: Two Race Suspension
- 2nd Offence: Season Suspension

TECH INSPECTION:

All classes (including visiting divisions) are required to go through technical inspection for safety before being allowed onto the track. **This does not guarantee that your vehicle will pass a post-race technical inspection.** The competitor's safety is paramount at CNS, and to that end, CNS officials reserve the right to require repairs or improvements to any race vehicle or component prior to participating in any racing event or practice. All vehicles must cross the scales with Driver inside without dragging. All Trucks must pass a yearly safety inspection prior to competition. Below are the minimum requirements:

- **Helmets:** Helmets must meet the specifications set forth in the Federal Motor Vehicle Safety Standard Regulations or meet the specifications set forth by the American National Standards Institute, Inc. Current specifications require that helmets meet a minimum of SA- 2010 standard and that **NO** motorcycle approved helmets are used in automotive competition.
- **Fire Suits, shoes, and gloves:** All drivers must wear at minimum either a two-piece or one-piece single layer fire protectant uniform meeting current SFI-3 or better standards. Flame retardant undergarments **HIGHLY** recommended. Driving shoes and gloves are required and must meet current SFI and FIA standards. Rips and tears are not allowed on any aforementioned gear.
- **Seat Belts:** Nylon safety belts and harnesses are required. It is required that each driver be fastened in with at least a 5-point safety harness, including 3 inch wide lap belt, two(2) 3 inch wide over the shoulder straps (as it passes over the head and neck restraint device) and crotch straps. No sternum latches allowed. No "Y" or "V" belts allowed. All belts and harness apparatus must have the manufacturers date tag attached and dated from approximate time of purchase. Maximum usage is three (3) years from the date on the belt. It is highly recommended that any manufacturer's tags that pass under any adjuster be removed and kept for technical inspection. All belts must be installed in a manner so as not to contact sharp objects and must not have knots, twists or tears in the installation. All seat belts must be bolted solidly to the roll cage with approved eyelets designed for this purpose. Seatbelts that are contaminated by oils, greases, fuels will not be allowed. There cannot be any holes, tears or fraying of any belt. **Proper Seat belt mounting is depicted below and will be strictly enforced:**

SAFETY BELT DIAGRAMS:

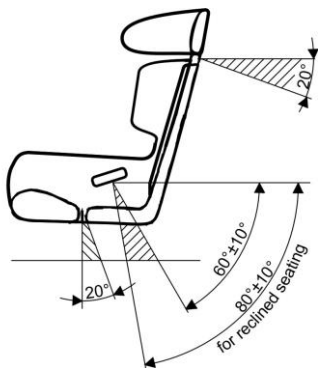

LAP BELT ANGLE

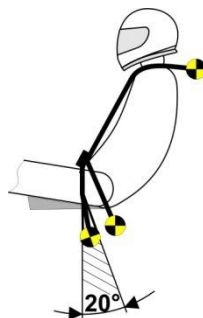

SHOULDER BELT ANGLE

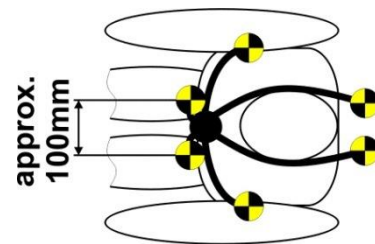

SUB STRAP ANGLE

It is recommended that one horizontal bar be located at the shoulder height (0 degrees to -10 degrees) in which seat belt shoulder harness is to be attached.
 (Minimum tubing size: 1.5" O.D. .095 wall)

Recommended option #2 allows belt to go over horizontal bar located at the shoulder height (0 degrees to -10 degrees) and be attached to a second horizontal bar, provided that lower bar is vertical to, and no more than 8 inches below upper bar.
 (Minimum tubing size: 1.5" O.D. .095 wall)

PROPER SHOULDER

Horizontal Line through "H" Point

Top of Shoulder

10°

"H" Point
 (Center of Occupant's Hip)

WRAPPING OF HARNESS BELTS:

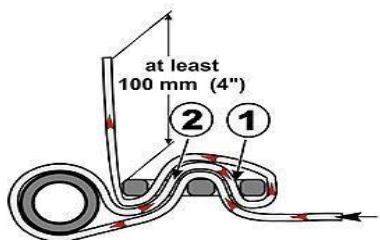
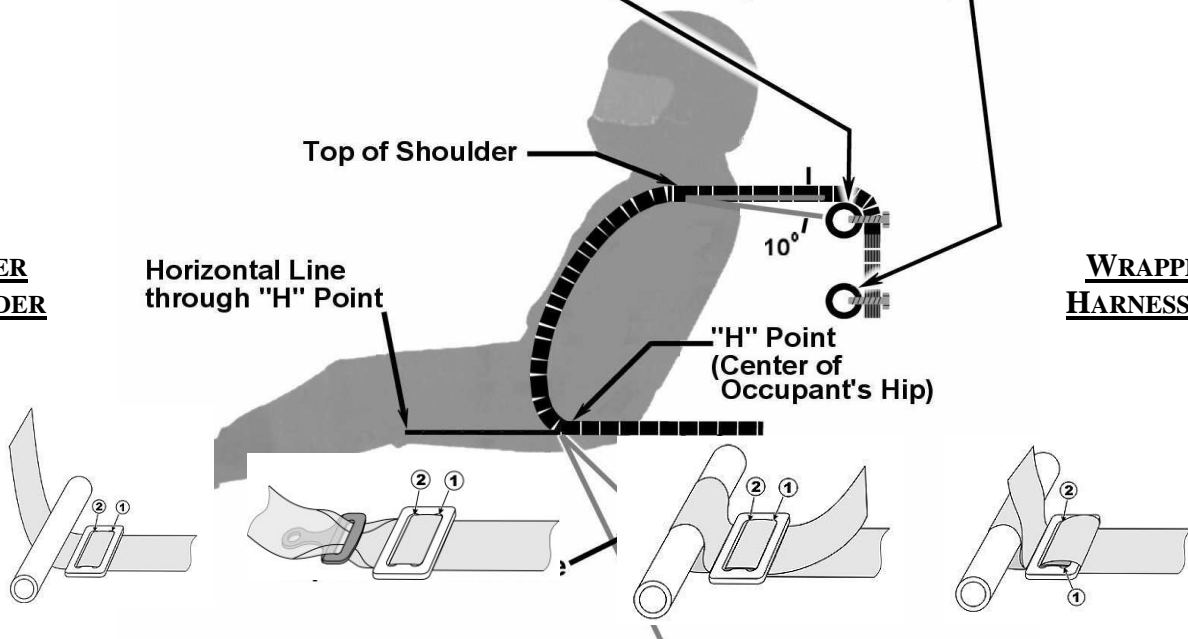

3-bar adjuster should be positioned as close possible to harness bar or snap-on/bolt-on bracket. This applies to both lap and shoulder belt points. The final wrap as pictured in Figure 8 is mandatory. At least 4" of webbing material must extend out from the adjuster after this final wrap is completed

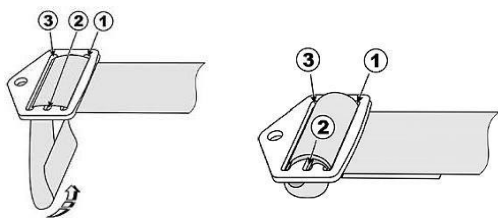

POSITIONING AND USE OF LAP BELT MOUNTING POINTS:

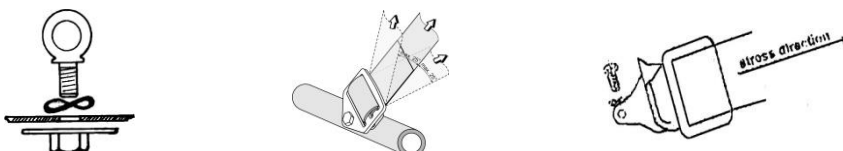

Lap belts must be positioned so that the mounting hardware through which the webbing passes is loaded in plane as the webbing passes through the seat and over the pelvis. Bolt-on brackets must be allowed to swivel and snap-on eye bolts must be aligned (using wavy washers) to allow directional loading.

- **Neck Support:** All drivers except F-8 shall connect their helmet to an approved head and neck restraint device/system which is SFI-approved at any time while on the racetrack. A "Hutchens" device, "HANS" or equivalent that positively attaches to the drivers helmet is required. High-density foam "horse collars" or equivalent, are not considered a sufficient support device. All Neck supports are subject to approval by Tech committee. The head and neck restraint device/system, when connected, should conform to the manufacturer's mounting instructions, and it should be configured, maintained and used in accordance with the manufacturer's instructions. It is the responsibility of the driver, not CNS, to ensure that his/her device/system is SFI-APPROVED, correctly installed, maintained and properly used.
- **Window Net:** All divisions will have window nets except F-8 and visiting classes where they are not required. Driver's window nets must be constructed of no less than a **3/4"** webbing and securely attached at the bottom with a quick release catch at the top. The forward edge of the window net, when in the closed position, should be in line or forward of the steering wheel. The net's upper and lower mounts must be welded to the roll cage. Nets are required at any time the car is on the racing surface. No object may be attached to the window net at any time. The rationale is: this changes the rating of the window net, thus making it a safety violation. It may also impede the ability of safety workers in the event of an emergency. Examples of they include hanging stuffed animals or wire-tying Lexan to them.
- **Aluminum Seat/Mounting:** Only aluminum racing type seats are permitted. The use of a fiberglass type seat is not allowed. Seat must be located a minimum of 8 inches from left side door bars to the center of the seat. Head surround type seats with appropriate shoulder supports are **mandatory**. They shall provide rigid support around both sides of the helmet and across the back. No car or truck will be allowed to participate in any on track activities without a head surround and shoulder supports properly installed on the seat. Mounting and configuration must be approved by CNS tech officials.
- **Safety Pad:** The center of the steering wheel must have a safety pad.
- **Roll bar padding:** All roll bars within the drivers reach must be padded with hi density padding or fire retardant padding acceptable to CNS Officials.
- **Driver's side deflector plates:** Driver's side deflector plates are *required* for all divisions, located outside left door bars and foot protection bars, minimum 1/8 inch steel plate welded to roll bars. Plating must meet track official's approval.
- **Cut-off Switch:** A labeled ON/OFF rotary type Master Switch, with ON being in the clockwise position, must be located at or on the front of the dash in the center. Pro Trucks may place the cutoff switch on the tonneau cover. The switch must be wired to the battery cable in a manner that will cut off all electrical power in the car. Visiting classes must have this switch as well but placement may vary due to constraints.
- **Air Filter:** The only approved type of air filter element in any CNS sanctioned division will be the paper media type. Visiting divisions must have the approval of CNS to vary from this requirement.
- **Studs:** No hollow gun drilled, tubular bolts or studs allowed. Each stud must protrude through lug nut a minimum of two (2) threads.
- **Wheel weights:** Wheel weights are **NOT** allowed.

- **Plugs:** All plugs for rear ends, transmissions, oil pans, and oil tanks must be drilled, securely installed, and safety wired. See penalty section for fines regarding not following this rule.
- **Batteries:** Only one (1) battery per vehicle is permitted, and must be effectively secured and covered.
- **Fuel Filter:** No glass or plastic fuel filters are allowed
- **Fire extinguisher:** Must have at a minimum one (1) 2.5 lb fire extinguisher fully charged with an indicator gauge within reach of driver securely mounted with a metal quick release bracket.
- **Lead Mounting:** Securely bolted to the frame, painted white, and marked with the car number.
- **Throttle Linkage:** Two (2) opposing throttle springs are required.
- **Side Mirrors:** Side mirrors will be permitted and must not protrude beyond the vehicle's door panel and must not be constructed of glass. This rule applies to all divisions except trains.
- **Fire Wall Sealed:** No gaps or oversized penetrations.
- **Tow Hooks Front and Rear:** All vehicles must have 4 tow hooks mounted to the chassis. Tow hooks must be mounted to the underside of the chassis. 2 hooks should be mounted at the extreme front of the chassis forward of the front tires. Two hooks must be mounted at the extreme rear of the chassis behind the rear tires. All hooks must be able to except a 3" strap. Clearly identifying them from other components is highly recommended.
- **Body Exterior:** No ragged or spear like devices (including jack post stubs) may protrude from the vehicle body.
- **Transponder Location:** Required for all oval track cars. Fourteen Feet and Two inches (14'2") for Super Late Models, Late Models, Pro Trucks, and Super Stocks measured, and one Hundred and Six inches (106") for GAM's measured from the leading edge of the race car.
- **Impound:** Please refer to the Rules specific to the Division for any applicable Impound Policy.

CAR & TRUCK REQUIREMENTS:

CAR/TRUCK NUMBERS: No more than two numeric digits will be allowed for any car/truck, including Trains. Numbers must be legible; they must be a minimum of 20 inches in height with 4 inches of spacing between them. Trains are required to have a minimum of 30 inch numbers. Numbers must be easy to read from both sides and the top number is to be oriented for passenger side view. Numbers must be centered and in a contrasting color to the body paint. Any letter added to or included with a car number must be at least 12" tall and clearly visible on all sides of the car / truck. Additionally, numbers that are 6 inches in height must be on the right front nose and right rear tail light cover. If a car / truck does not meet the entire requirement regarding number specifications, it will not be scored and therefore no purse or points will be awarded. No Duplicate Numbers will be permitted.

DECALS: NASCAR Weekly Racing Series decal packs and CNS contingency sponsor decals will be provided to each competing team and are required for competition and awards. All of the decals of the various manufacturers who support the NASCAR Weekly Racing Series must be displayed on the front fender area as indicated by NASCAR. Use of the displayed products may also be required. All vehicles must have the required vehicle weight posted on the passenger side A-Pillar.

TIRES: *Tire Management Requirements:* The first scheduled night of your division will be the first night of your per-night cycle. You will put new tires on your first scheduled night of competition and run them consecutively for 2-5 nights of competition depending on the Division; then you will start the cycle over in alignment with the completed CNS scheduled nights.

Not starting on the first race of a cycle: If any competitor chooses to compete when they are out of cycle with the scheduled cycle, they will compete under these penalty rules:

1. They start at the back of the slow dash
2. CNS Officials will attach 35lbs weight on competitor's car in a location of CNS Officials placement

FUEL: RACING FUEL ONLY PERMITTED AND MUST BE PURCHASED FROM CNS DIRECTLY, as this will enable us to check for any additives. No nitrous oxide, oxygen containing compounds, or any other additives will be allowed. (CNS Officials will be monitoring this and if at any time, it is determined that you are not using fuel purchased from CNS, you will be penalized and/or receive no purse or points) Fuel color must match the CNS fuel sample from pump. Super Stock and Pure Stock divisions have an exception and will be allowed to run "pump gas". Grand American Modifieds also have an exception and are allowed to run alcohol provided a minimum six inch letter "A" is affixed at the rear of the side door numbers for emergency crew identification. No fuel cooling devices of any type are allowed in any division.

Anti-Siphon Valve: Anti-siphon valve is required for all divisions (Oberg part no. 706-SV-0820).

MISC:

- Carb stud / bolt and intake bolt must be drilled for a seal.
- Brakes must be in good working order and no carbon fiber brake components are allowed.
- Mufflers are **mandatory** and must control the noise level to 98 DBA or less.
- All Cars/Trucks will not be permitted to carry onboard computers, processors, recording devices, traction control devices, or digital readout gauges. Approved video recording devices are permitted.
- No colored or tinted Lexan, decals, or graphics are allowed on front or rear windshield areas.
- The use of ethylene glycol (anti-freeze) or similar products is strictly prohibited. Water Wetter, Motormax or similar at CNS discretion and anti-rust products are permitted.
- Possession and use of tire treatment of any kind is strictly prohibited.
- The use or installation of an open or closed loop vacuum type system to evacuate air from the engine is a speed enhancing alteration and is not allowed in any division.
- No belt or gear driven cam drives are permitted in LM, PT, SS, F8, and PS Divisions.
- No operator controlled, computer controlled or automatic weight transfer, weight shifting, or weight altering or techniques will be allowed.
- If a car is deemed to repeatedly contact the racing surface it will be immediately black flagged with the corresponding finish.
- No engine, chassis or shock adjustments are allowed from the driver's compartment. (Compartment is defined as anything the driver can touch while seated in the driving position.) The only driver adjustment allowed is brake bias.
- The SPEED LIMIT IS 5 MPH IN THE PITS!**
- All teams competing in any event must have a fully charged 10 to 13 pound halon or equivalent dry chemical fire extinguisher in their pit area.
- Drivers and teams must shut off engines and stop the movement of cars during the playing of the National Anthem and during drivers meetings. This includes generators.
- No passengers at any time aboard race vehicles and/or trailers.
- There will be no motorized or un-motorized vehicles of any kind, i.e.: bicycles, tricycles, 3-wheelers, 4-

- wheelers, or golf carts allowed in the pit area unless specifically pre-approved by CNS Management.
- Track Officials shall be empowered to permit minor deviations from any of the specifications herein. Officials may, at their discretion, impose any further restrictions that in his/her opinion does not alter the minimum acceptable requirements. No expressed or implied warranty or safety shall result from any such alteration of specification. Any interpretation or deviation of those rules is left to the discretion of the Track Officials. Their decisions are final.
 - In keeping with the CNS commitment to maintaining proper balance in the competition arena, it may be necessary for CNS Management to make rule changes and/or rule modifications from time to time. Such changes are designed to enhance close competition. CNS's goal of a full starting field in each race, that matches cars as equally as possible is certainly in the overall best interest of the sport. No equipment of a race car will be considered as having been approved by reason of having passed through inspection "unobserved". If this rule book does not specifically state that a change, modification or addition is legal, then a competitor must consider that change, modification or addition as illegal. If a question arises about the legality of a change, modification or addition that is not covered in this rule book, the question must be answered by CNS in writing, and that decision is final.
 - Every vehicle must maintain space on their windshield (or other approved area) for the placement of the Division Sponsor decal. A Division Sponsor Decal must be in place prior to competing in the A Main event, or points will not be awarded.
 - **Out-of-town cars/trucks:** Out-of-town cars/trucks not registered with CNS, which do not meet CNS specifications, may be subject to weight adjustment in order to compete in any event, with full disclosures of visiting track rules.
 - **TRACK RULES:** Colorado National Speedway track rules shall prevail. If this rule book does not specifically state that you may change, add, or alter something, then you must consider that change or modification illegal until approval is given.

SUSPENSION:

The following rules do not apply to the Super Late Model division or where specifically addressed in the Divisional Rules

- No bump stops will be allowed. No type of mechanical suspension travel limiting devices, coil binding or other methods will be allowed. Suspension travel must not be limited by shock absorbers and / or components or mounting location.
- When coil over springs are used they must be conventional, closed and ground on both ends. Coil over springs that taper down on the ends to eliminate the need for shock adapters will be allowed. No custom coil over or custom conventional springs will be allowed. No progressive / digressive coil over or conventional springs will be allowed. Coil over and conventional springs must be utilized as manufactured. See individual division rules for spring eligibility.
- Trailing arms and panhard bar may not incorporate dampening devices of any type (Except Super Stock Division using stock rubber or polyurethane bushings).

CRATE MOTOR RULE:

- Factory sealed "crate" motors must remain as manufactured with no rebuilding or "freshening" allowed. Rebuilt or unsealed "crate" motors are ineligible for competition unless approved from CNS in writing.

RADIO REQUIREMENTS:

Two-way radios are required in the Super Late Model, Late Model, ProTruck, and G.A.M. divisions. An area will also be reserved in the Pit grandstands for a maximum of two crew chief's or crew member's with radio communications to his/her driver during **"A" Main Events and Qualifying Events**.

Participants in any division that are not using radios for spotting will be required to utilize the Receiver technology. Car Numbers must be clearly visible on individuals that are spotting for a race participant while in the spotting area at all times. No lap counting or timing devices are allowed in any race car/truck.

TECH INSPECTION:

ALL cars/trucks will go through tech prior to qualifying, qualifying races, and/or "A" main events, at the discretion of CNS track officials. No tools will be allowed into the pre-race technical inspection area. This will include any types of lifting devices. Additionally, no one will be allowed to physically lift any race car in an attempt to "set the car on the shocks." Please prepare your car in your pit area or before the car enters the inspection area. In the event that your race car fails to pass pre-race tech you will be allowed to leave the tech area and fix the discrepancy and return to the end of the line. However, you will forfeit your original starting position and be lined up in the rear of your next race.

It is very important that you come to tech ready to race. Please refer to your respective rules and be aware that no grace should be expected from a track official. When a race car is on the scales, all crew members will be expected to step far enough away from the car so that the weights can be accurately measured. The driver will be expected to sit in a normal driving position, steering wheel in place, with their helmet in their lap. After a race vehicle has passed the scales only one crew member is allowed with the Driver up to the start of the barriers. It is highly recommended that the Driver stay in their car / truck and ready to enter the track. Left side % weight can be checked before or after race in ALL Divisions (without adding fuel).

Main Event Trophies: All Main Event Trophies will be kept in Tech and presented to the winning driver upon clearing Tech inspection. Double Feature Events will require all first feature winners to come to Tech automatically after second feature.

RACE PROCEDURES:

Race event start and restarting procedures:

All competitors must maintain a nose to tail formation with no weaving or tire warming / scrubbing after the one to go signal has been given at the flag stand. No brake checking or erratic starting is allowed and may subject the offender to loss of starting position. Pace car speed must be maintained until the green flag is displayed by the flagman. For all original starts, the flagman starts the race at the start line in turn 4. The pole setter and number 2 position competitor will be as close to nose to nose as possible with the pole setter in front of number 2 competitor no more than a fender length at the start line. The remainder of the field shall be nose to tail, double file formation at pace car speed. The full field of competitors may not fall out of line to the inside or outside line until they are through turn 1 (No three wide or four wide into turn 1).

For feature races: except the figure-eight division:

All restarts will be in double file formation with the same starting procedure as original starts. Feature event double file restarting procedures will allow the leader of the event at the time of the caution to choose between the inside or outside line. Position number two will be set by that competitor taking the opposite line of the leader. The rest of the lineup will be set according to running order with odd positions on the inside and even positions

on the outside. Double file restarts will be conducted throughout entire events. The figure 8 division will not restart double file in any events.

FLAG DEFINITIONS:

GREEN Signifies the START OR RESTART OF A RACE:

When the yellow light goes out during the parade lap, the drivers should anticipate the green flag on the next lap. All vehicles must be nose to tail, double file and hold the pace car speed until the flag is thrown. Acceleration begins at the stripe in turn four and drivers are not to pass until the start finish line. Any vehicle jumping positions or holding up the race will be sent to the rear of the field. If the yellow flag comes out after the green flag has been thrown and the first lap has not been completed, an original restart is required less the vehicles involved or penalized. Vehicles may be allowed onto the racing surface from the track entrance during green flag laps by direction of turn four CNS officials only. **All vehicles must take the original green flag to compete in any event.** See starting and restarting procedures.

YELLOW Signifies a CAUTION / SLOW DOWN IMMEDIATELY:

No racing to the yellow flag & No passing allowed. Hold your position. Yellow Flag laps will not count. (Unless specified for special events) The re-start line-up will be determined from the last completed green flag lap. Two cars making contact and determined to be at fault for a caution or red flag may be sent to the rear of the field at CNS official's discretion. Any time a yellow is displayed within five laps of the finish of any feature event, all lapped cars will line up at the rear of the field. Any cars / trucks stopping on the track to discuss anything with officials unless at official's request, crew members, fans, etc., or going into the pits during a yellow flag, will be sent to the rear of the field at CNS official's discretion. **Absolutely no one** from the pits is allowed onto the track or infield during a yellow flag.

RED Signifies the RACE IS STOPPED!!!

The race must be stopped immediately regardless of the position of the vehicle on the track. ALL drivers will be brought to a complete stop by CNS officials. Any driver that has not come to a complete stop immediately will be directed to the pit when it is safe to do so and disqualified. *It is imperative that the flags are followed!* In the event of a Red flag, lineups will be determined by the yellow flag rule. **Absolutely no one** from the pits is allowed onto the track or infield during a Red flag. Safety crews, ambulance personnel, and track officials are the only people permitted to assist at the scene of an accident. Vehicles that are not ready or prepared to race will be pushed into the pits or infield and not allowed to further compete.

BLACK Signifies to REPORT TO PITS IMMEDIATELY:

A driver receiving a black flag must go immediately to the pits. The black flag will be waved once in a warning for unacceptable driving and/or vehicle malfunction. When a Black Flag is displayed, a second time, it will signify the last lap scored for a vehicle, and if said vehicle does not proceed immediately into the pits, the appropriate fines and/or suspension will be utilized by track officials.

BLUE with DIAGONAL YELLOW STRIPE Signifies to Hold Your Line:

Shown to lapped traffic, vehicle will hold their line allowing leaders to pass by safely. Failure to comply will subject participant to penalties at the discretion of CNS officials.

WHITE Signifies the START OF THE LAST LAP:

Once the white flag is displayed, the checkered flag **will** follow. If the yellow or Red Flag is displayed during the White Flag lap, the race will be scored according the last completed lap and the race is considered complete. After the leader has taken the white flag, no attempts will be made at a green, white, checkered finish.

CHECKERED Signifies the END OF THE RACE:

When the checkered flag has been displayed to the lead vehicle, the balance of the field receives the flag on the same lap. Finishing positions will be paid according to most completed laps traveled in the least time, whether the vehicle is still running or not.

OFFICIAL EVENT COMPLETION:

All races will be run until the leader has completed the advertised distance *or* the official time limit is reached. However, if unforeseen circumstances prevent the completion of the advertised distance, the race will be considered officially complete after half the publicized laps have been completed by the leader provided circumstances make it impractical to continue the race within a reasonable time after it has been stopped. Should a yellow or red flag be displayed, where upon CNS officials elect to end a race regardless of the number of laps remaining, final scoring will be as follows: cars will be scored according to last completed “green flag” lap minus cars/trucks deemed to be at fault and/or cars/trucks involved in accident, as determined by CNS officials.

MINIMUM COMPETITIVE STANDARD

Drivers must be able to meet a minimum competitive standard in the Division in which they are competing. If, in the interest of driver and race safety, Track Officials determine that a Driver is failing to meet the minimum competitive standard of that Division, that Driver will be black flagged and / or not allowed to compete.

POST RACE POLICY

- Important note – Immediately following each main event, the top 3 cars/trucks and possibly mystery guests will report directly to tech without stopping anywhere in the pit area. Failure to follow this rule will result in automatic disqualification, with no purse or points for that event

OFFICIALS’ PRIVILEGE: Officials may, at their discretion, check any race vehicle at any time. Officials reserve the right to impound any race vehicle at any time.

ROUGH DRIVING: In the event that a driver causes another competitor to spin, and if in the opinion of CNS officials, it was anything other than a normal racing incident, you will be penalized. Driver intent is not judged, only the results. Normally, this means being put to the rear of the field, however, more severe penalties may be levied for repeat offenses or for extreme cases. This is a decision call on the part of CNS officials and is not subject to appeal. Any vehicle intentionally hitting another vehicle will be parked immediately, penalized finishing position, and/or fined. Any driver who stops their vehicle on the track to confront another driver or official will immediately be ordered to the pits.

DRIVER CHANGES: The replacement driver must be a NASCAR Licensed Driver for the division he /she is competing. Notice must be given to CNS Officials of a Driver Change, and the replacement driver must be a registered Driver with CNS (with the proper paperwork showing the Driver’s registration and car number). Any Driver change must be approved by CNS Officials prior to technical inspection and staging for the Event. This applies to every Division at CNS; including Trains. Each Driver must be registered in a unique number before competition. Should the Driver change occur after any preliminary event, the original Driver's prior results will be disregarded, and the new Driver will start at the rear of "A" Main Event, as appropriate. If a Driver changes cars at any time during the evening, the number on the new car must match the driver’s registration, and the driver will start at the back of the next scheduled race for that Driver. Driver receives all points – not the car/truck or owner. Once a race has begun, no driver or car changes are allowed.

CNS RULES PROVIDE FOR THE FOLLOWING PENALTIES:

Automatically start at the back, DQ for event, a point penalty, no purse money, monetary fines, finish position deduction, or combinations of the preceding for any infraction of the rules contained in this book.

DQ for event, No Points & No Money, Suspension & up to \$1000 FINE; or other appropriate penalty as determined by CNS Management.

FOR ANY TYPE OF UNSPORTSMAN LIKE CONDUCT, OR ANY ACTIONS DETRIMENTAL TO THE SPORT. EACH DRIVER IS RESPONSIBLE FOR HIS/HER PIT CREW, GUESTS, RELATED PARTIES, OR A PERSON ACTING ON THE DRIVER'S BEHALF.

DQ for event, No Points & No Money & \$500 FINE; or other appropriate penalty as determined by CNS Management.

For stopping and/or getting out of your race vehicle on the race track, without CNS Officials' approval.

DQ for event, No Points and/or No Money & \$500 FINE; or other appropriate penalty as determined by CNS Management.

For creating a yellow flag (or other delays) i.e.: parking a stalled vehicle on the track rather than rolling into the infield, spinning out and backing the vehicle onto the race track, etc.

DQ for event, No Points & No Money & \$200 FINE; or other appropriate penalty as determined by CNS Management.

If a race vehicle requested to go through Tech following any events stops or hesitates ANYWHERE in the Pit Area.

DQ for event, No Points & No Money & \$200 FINE; or other appropriate penalty as determined by CNS Management.

For any competitor ignoring the black flag or any other flag stand instruction. The Flagman will display the black flag for two laps ONLY. (If obeyed, the competitor will be scored accordingly)

DQ for event, No Points and/or No Money & \$200 FINE; or other appropriate penalty as determined by CNS Management.

For anyone found to be utilizing ethylene glycol (anti-freeze) or similar products are found in any vehicle at any time. Water Wetter, Motormax or similar at CNS discretion and anti-rust products are permitted.

DQ for event, No Points and/or No Money & \$50 FINE; or other appropriate penalty as determined by CNS Management.

For speeding in the pits, a violation only needs to be witnessed by one CNS Official and is NOT open for discussion. A second offense will be assessed a \$100 fine. Subsequent infractions can result in suspension from future CNS events at CNS official discretion.

\$50 FINE or other appropriate penalty as determined by CNS Management.

If at any time you oil down the track and it is determined that safety wire was not utilized.

\$10,000 Fine, Suspension, or other appropriate penalty as determined by CNS Management.

For any traction control device found on any vehicle. CNS offers up to a \$1000 reward for anyone that can identify and prove a race vehicle that is utilizing a traction control device.

Lead Ballast Fines

All lead ballast must be securely bolted to the frame, painted white and carry the car number. A minimum of a \$100 fine will be assessed for losing any lead or debris on the racing surface. A \$50 fine will be assessed for lead not marked with car number. A \$100 fine will be assessed for any lead discovered with the wrong car number.

Automatically start at the back. DQ for event, No Points and/or No Money; or other appropriate penalty as determined by CNS Management.

For any infraction of the General Rules Sections i.e.: Car/Truck numbers, vehicles that are too loud, etc.

Automatically Black Flagged or other appropriate penalty as determined by CNS Management.

Upon any 2 un-assisted spins during any one event (if black flag is obeyed, competitor will be scored accordingly)

Two Position Penalty for every position gained or other appropriate penalty as determined by CNS Management.

For passing on the inside before the Start/Finish Line on starts or re-starts in any event, and/or for running below the yellow line to gain positions. (When possible, penalty will be imposed at the next re-start; otherwise it will be scored accordingly at the end of the event.) For a Figure-8 competitor that runs out of bounds, unassisted, in the "X". For any competitor who passes to the right prior to the green flag. *See start and restart procedures.*

One LAP Penalty

Any vehicle that does not complete a full lap and instead, makes a half-lap by turning at the "X" on the F8 racing track during F8 or Train events.

Two LAP Penalty

Assessed on a per tire basis, for changing tire(s) during any event, that are not flat during a yellow or red flag condition, tire changes during an event must be approved by a CNS Official

ROOKIE OF THE YEAR:

Rookie honors will be available to Super Late Model, Late Model, ProTruck, Grand American Modified, Super Stock, and Figure-8 divisions, provided the following requirements are met: Driver may not have competed in more than 5 Main Events in the specific division he/she wishes to compete in for Rookie honors. You must declare rookie status by marking the "Rookie" application block noted on the Vehicle Registration Form. A completed rookie application must accompany a completed car registration form. To be eligible for rookie status the driver cannot have competed **twice** in an upper division, and must provide CNS management with adequate experience information. If two or more competitors are tied in points at the season's end, the CNS Rookie of the Year will then be determined by: 1) total number of Main Event wins; (if still tied), total number of Main Event second place finishes, etc. respectively, until the tie is broken.

POINTS:

If two or more competitors are tied in points at the season's end, the tie breaker will then be determined by: 1) total number of Main Event wins; (if still tied), total number of Main Event second place finishes, etc. respectively, until the tie is broken.

PROTEST AND TEARDOWN FEES AND PROCEDURES:

- **CNS Officials reserve the right to refuse a protest.**
- **CNS Officials reserve the right to test and teardown suspect components (to include engines) based on competition level or any other reasonable observation at the discretion of the Track Promoter or Track Steward.**
- **CNS reserves the right to seal a suspect motor for tear down at a later date. If at such later date the engine is found to be illegal, the competitor will lose points and purse for all events from the time of sealing.**

All protests must be filed in writing to the Track Steward, and fees are payable by **cash** only. See protest form at end of section (Exhibit 1). It is recommended that you allow the Protestor and /or CNS Officials to tear down any item(s) that have been protested.

Colorado National Speedway provides for the following penalties for refusing a protest:

- First Offense of refusal will be the total loss of points and money for that event
- Second Offense of refusal will be the total loss of points and money for that event and a \$250.00 fine.
- Third Offense of refusal will be the total loss of points and money for that event and a loss of all points for the season, along with \$500.00 fine.

*If you refuse a Protest Inspection, your car will be deemed illegal and you will be subject to the full monetary penalty associated with the Rule Violation. You must pay all fines against you before you will be permitted to compete in any future race event held at Colorado National Speedway.

Protest Fees will be broken down as follows:

1. First, all necessary expenses will be paid out of the Fee.
2. Second, whether legal or not, 25% of the remaining Fee Money after expenses will automatically go to CNS.
3. Last, the remaining Fee Money shall be split as follows:
 - a. If Protested Car is *Legal* – remaining Fee goes to Protested Driver.
 - b. If Protested Car is *Illegal* – remaining fee goes to Driver who filed Protest.

Protest Categories and Fees:

<u>CATEGORY:</u>	<u>FEE:</u>
<input type="checkbox"/> ENGINE	\$1,000
<input type="checkbox"/> CRATE MOTOR	\$750
<input type="checkbox"/> CHASSIS	\$500
<input type="checkbox"/> TRANSMISSION	\$500
<input type="checkbox"/> CLUTCH	\$500
<input type="checkbox"/> REAR END	\$300
<input type="checkbox"/> EXHAUST	\$200
<input type="checkbox"/> PAN REMOVAL AND VISUAL CRANKSHAFT INSPECTION	\$400
<input type="checkbox"/> 1 TIRE – SENT TO LAB (SINGLE TIRE ONLY)	\$150
<input type="checkbox"/> BODY UTILIZING THE “REFEREE”	\$250
<input type="checkbox"/> SCORING PROTEST (1 HOUR TIME LIMIT)	\$100
<input type="checkbox"/> OTHER: _____	@ CNS DISCRETION

IF ILLEGAL, THE DRIVER MAY BE SUBJECT TO FINE, MAY FORFEIT ALL POINTS, AND/OR MAY FORFEIT ALL PRIZE MONEY FOR THAT EVENT, and the balance of the protest fee will be returned to the protester. The illegal vehicle may then be subject to further fines which must be paid directly to CNS prior to the driver competing in another CNS event in any class.

Any driver or car/truck owner whose car/truck finishes that Main Event may submit a written request for tear-down within 20 minutes of the finish of the race with the Track Steward. All disassembly may be done immediately or at a designated location and time per mutual agreement of protested vehicle owner, protester, and CNS Track Officials. If driver or vehicle owner will not honor the tear-down, they are automatically disqualified and be subject to penalties outlined above.

The Track Promoter or Track Steward shall decide whether an issue is worthy of a protest, and if so, shall decide the protest as promptly as possible. CNS Officials shall inform all parties to the protest of the final decision. If a

certain issue is deemed by officials to not be protestable, the protester will not be required to put up any associated fee. However, if officials consider the issue to be illegal, protested driver may be subject to fines and/or loss of points.

- All Illegal parts found at any time will become property of Colorado National Speedway and will not be returned for any reason. No exceptions.
- If any vehicle is disqualified three times in a season, the driver will lose all accumulated Championship points awarded.

A \$100 “Scoring Protest” fee is required for SLM, LM, PT, GAM, SS, F-8, and Pure Stocks Divisions only. ALL SCORING PROTESTS MUST BE MADE WITHIN ONE HOUR OF THE POSTING OF THE RACE RESULTS to the Track Promoter or Track Steward – in writing – to have scorers recheck any Main Event. The \$100 fee will go directly to CNS unless a scoring error is discovered; in which case the fee will be returned to the driver protesting, and the scoring will be adjusted. this protest has been added for scoring discrepancies only.

NO protests will be accepted in regards to CNS Officials’ calls. ALL RACE RELATED CALLS ARE MADE BY ON-TRACK OFFICIALS, FLAGMEN, AND PIT SIDE OFFICIALS ONLY! Any driver, crew, or team member who confronts a CNS Official about a race related call is subject to a fine, disqualification, or both.

Any driver or car/truck owner whose race car/truck competed in the Main Event may file a written protest **within 20 minutes** following the posting of the results of the race.

YOU MUST BE WITHIN 5 POSITIONS IN THE FINISHING ORDER OF THE CAR YOU ARE PROTESTING, EXCEPT ON THE LAST NIGHT OF THE SEASON.

APPEAL PROCEDURE

This section (Appeals) applies only to decisions made by CNS Track or Tech Officials (including penalties and / or disqualifications) but does NOT apply to a scoring matter (which must be handled the night of the race) or a Protest which concerns another driver or team (see Protest section, above). All Appeals must be submitted, in writing, to either a Track Official or to the Speedway Main Office no later than 5pm on the Monday immediately following the event in question. There are no exceptions to this rule, and any Appeal Form received after the 5pm deadline will not be considered.

- A written appeal form may be hand-delivered to the Speedway’s Main Office, may be faxed to 303-828-2403, or may be emailed directly to the Speedway at tech@coloradospeedway.com.
- Because there is no charge to file this Appeal, CNS management reserves the right to refuse to consider any Appeal which does not meet basic minimum standards. However, the Appealing Party is responsible for any Fees and Costs incurred as a result of the Appeal.
- A properly submitted Protest Form shall be reviewed by at least three (3) Members of the current year’s Rules Committee within 48 hours of the submission. The decision of the Committee will be posted publicly on CNS Social Media (Facebook, CNS App) and in the CNS Tech News within 24 hours of the decision. The person filing the Appeal shall be notified by phone prior to the public announcement of the decision.

NOTE: Any party filing an Official Appeal who attempts to plead his or her case on Social Media (Facebook, etc.) or complicates the issue by disputing Official Decisions outside of the Appeals Process shall void his or her right to Appeal. A CNS Appeal Form is attached below as Exhibit 2.

EXHIBIT 1

**COLORADO NATIONAL SPEEDWAY
PROTEST FORM**

SEE GENERAL RULES FOR PROTEST AND TEARDOWN PROCEDURES

TODAY'S DATE: _____

TIME OF SUBMISSION: _____

TIME RACE RESULTS POSTED: _____

YOUR NAME: _____ YOUR PHONE# _____

YOUR DIVISION: _____ YOUR CAR # _____

PROTESTED CAR

COMPETITOR DIVISION: _____ CAR # _____ COMPETITOR NAME: _____

PROTEST CATEGORIES AND FEES

	<u>FEE:</u>
<input type="checkbox"/> ENGINE	\$1,000
<input type="checkbox"/> CRATE MOTOR	\$750
<input type="checkbox"/> CHASSIS	\$500
<input type="checkbox"/> TRANSMISSION	\$500
<input type="checkbox"/> CLUTCH	\$500
<input type="checkbox"/> REAR END	\$300
<input type="checkbox"/> EXHAUST	\$200
<input type="checkbox"/> PAN REMOVAL AND VISUAL CRANKSHAFT INSPECTION	\$400
<input type="checkbox"/> 1 TIRE – SENT TO LAB (SINGLE TIRE ONLY)	\$150
<input type="checkbox"/> BODY UTILIZING THE “REFEREE”	\$250
<input type="checkbox"/> SCORING PROTEST (1 HOUR TIME LIMIT)	\$100
<input type="checkbox"/> OTHER: _____ DISCRETION	@ CNS

TOTAL PROTEST FEE: \$ _____

RESULT OF PROTEST: _____

*If you refuse a Protest Inspection, your car will be deemed illegal and you will be subject to the full monetary penalty associated with the Rule Violation. You must pay all fines against you before you will be permitted to compete in any future race event held at Colorado National Speedway.

Protest Fees will be broken down as follows:

1. First, all necessary expenses will be paid out of the Fee.
2. Second, whether legal or not, 25% of the remaining Fee Money (after Expenses) will automatically go to CNS.
3. Last, the remaining Fee Money shall be split as follows:
 - a. If Protested Car is *Legal* – remaining Fee goes to Protested Driver
 - b. If Protested Car is *Illegal* – remaining fee goes to Driver who filed Protest

EXHIBIT 2

COLORADO NATIONAL SPEEDWAY

APPEAL FORM

Name of Party filing this Appeal: _____ Phone #: _____

Division and Car #: _____ Date of Appeal: _____ Date of Race: _____

Brief description of Decision being appealed (*please write legibly*): _____

GENERAL RULES FOR APPEAL:

1. This form only applies to decisions made by Track or Tech Officials (including penalties and / or disqualifications) but does NOT apply to a scoring matter (which must be handled the night of the race) or a Protest which concerns another driver or team. The Protest Form is a separate document and can be found in the CNS General Rules packet available online at coloradospeedway.com.
2. All Appeals must be submitted, in writing, to either a Track Official or to the Speedway Main Office no later than 5pm on the Monday immediately following the event in question. There are no exceptions to this rule, and any Appeal Form received after the 5pm deadline will not be considered.
3. A written appeal form may also be faxed to 303-828-2403 or may be emailed directly to the Speedway at gmbrian@coloradospeedway.com.
4. Because there is no charge to file this Appeal, CNS management reserves the right to refuse to consider any Appeal which does not meet basic minimum standards.
5. A properly submitted Protest Form shall be reviewed by at least three (3) Members of the current year's Rules Committee within 48 hours of the submission. The decision of the Committee will be posted publicly on CNS Social Media (Facebook, CNS App) and in the CNS Tech News within 24 hours of the decision. The person filing the Appeal shall be notified by phone prior to the public announcement of the decision.
6. Any party filing an Official Appeal who attempts to plead his or her case on Social Media (Facebook, etc.) or complicates the issue by disputing Official Decisions outside of the Appeals Process shall revoke his or her right to Appeal.

Signature of Party filing this appeal: _____ Date: _____

Exhibit 3: CNS Points System:

On a regular night of racing, points will be awarded as follows:

Position	Dash/ Fast Dash Points	Feature Points
1	3	40
2	2	38
3	1	36
4	0	34
5	0	32
6	0	30
7	0	28
8	0	26
9	0	24
10	0	22
11	0	20
12	0	18
13	0	16
14	0	14
15	0	12
16	0	10
17	0	8
18	0	6
19	0	4
20	0	2
21	0	2
22	0	2

*A DNS or DQ results in 0 points for the feature

*If more than 20 cars, 2 points will be rewarded from 20th position and down.

On a night with **no dash races**, points will be awarded as follows:

Position	Qualifying Points	Feature Points
1	3	40
2	2	38
3	1	36
4	0	34
5	0	32
6	0	30
7	0	28
8	0	26
9	0	24
10	0	22
11	0	20
12	0	18
13	0	16
14	0	14
15	0	12
16	0	10
17	0	8
18	0	6
19	0	4
20	0	2
21	0	2
22	0	2

*A DNS or DQ results in 0 points for the feature

*If more than 20 cars, 2 points will be rewarded from 20th position and down.

Colorado National Speedway Rules: General Rules
 Last Revised: December 14, 2024

On a night with **double features** (no dash races) the points will be as follows:

Position	Feature #1 Points	Feature #2 Points
1	24	40
2	22	38
3	20	36
4	18	34
5	16	32
6	14	30
7	12	28
8	10	26
9	8	24
10	6	22
11	4	20
12	2	18
13	2	16
14	2	14
15	2	12
16	2	10
17	2	8
18	2	6
19	2	4
20	2	2
21	2	2
22	2	2

*A DNS or DQ results in 0 points for the feature

*If more than 20 cars, 2 points will be rewarded from 20th position and down.

Bandolero Points:

Bandits-

Position	Dash/ Fast Dash Points	Feature Points
1	3	20
2	2	18
3	1	16
4	0	14
5	0	12
6	0	10
7	0	8
8	0	6
9	0	4
10	0	2
11	0	2
12	0	2
13	0	2
14	0	2
15	0	2
16	0	2
17	0	2
18	0	2
19	0	2
20	0	2
21	0	2
22	0	2

*A DNS or DQ results in 0 points for the feature

*If more than 10 cars, 2 points will be rewarded from 10th position and down.

Outlaws-

Position	Dash/ Fast Dash Points	Feature Points
1	3	40
2	2	38
3	1	36
4	0	34
5	0	32
6	0	30
7	0	28
8	0	26
9	0	24
10	0	22
11	0	20
12	0	18
13	0	16
14	0	14
15	0	12
16	0	10
17	0	8
18	0	6
19	0	4
20	0	2
21	0	2
22	0	2

*A DNS or DQ results in 0 points for the feature

*If more than 20 cars, 2 points will be rewarded from 20th position and down